

WYNDHAM COLLECTION

Exterior Size - 67"L x 31-1/2"W x 23-1/2"H
Interior Size - 64"L x 28-1/2"W x 18"H
Depth at Drain - 18-1/2"
Drain To Overflow - 15"
Maximum Fill - 92 Gallons
Note - All Measurements are $\pm 1/2$ "

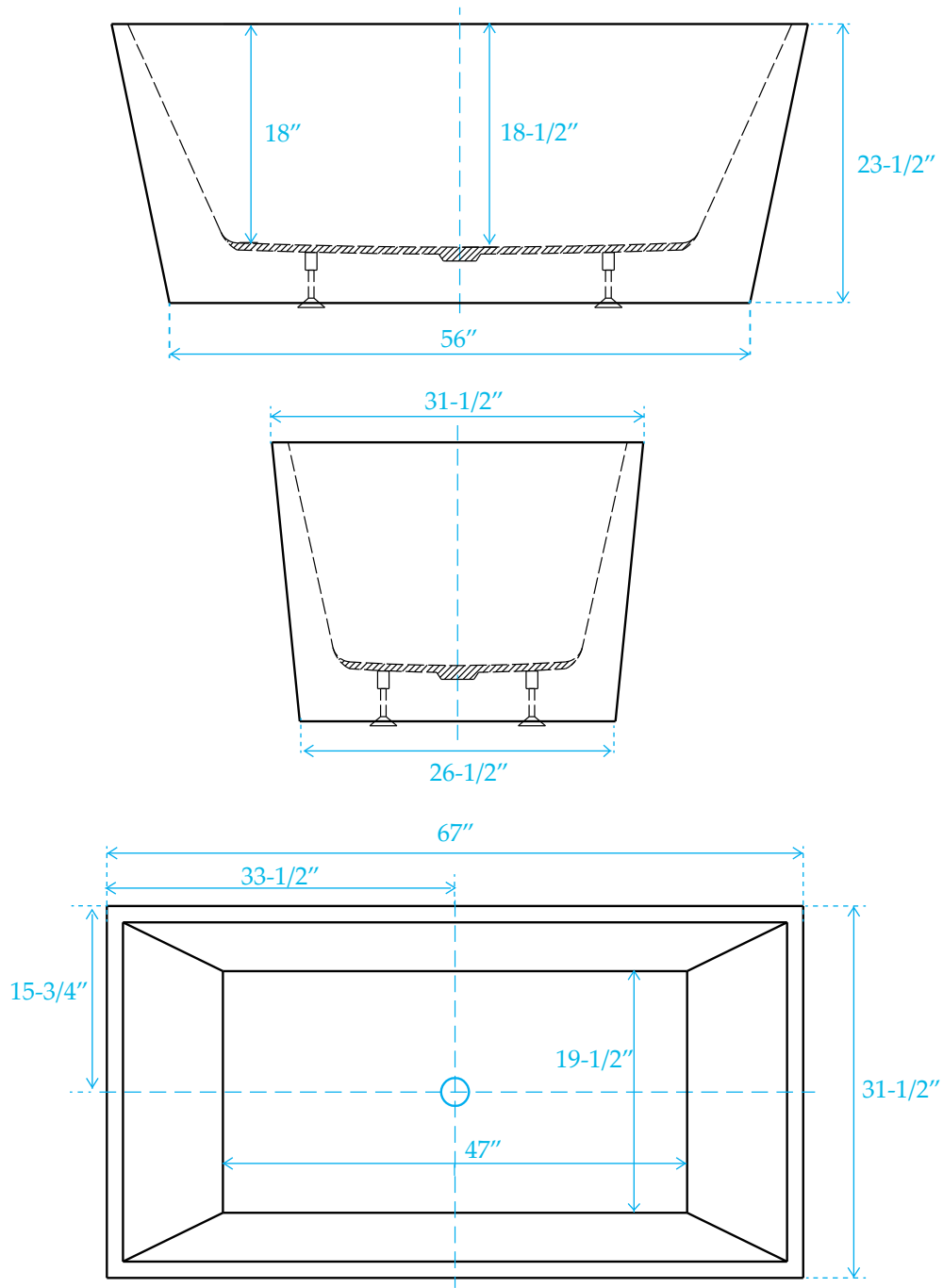

WC-BTK1514-67